

waterpik®

Waterpik® Water Flosser Model WF-06

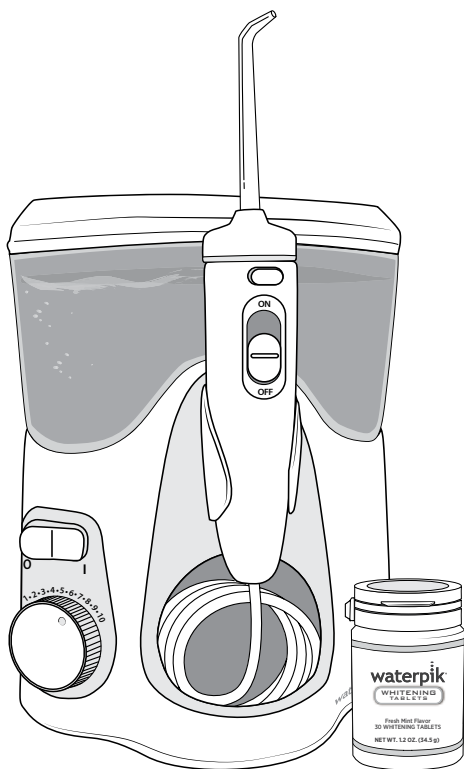

.....
www.waterpik.com

IMPORTANT SAFEGUARDS

IMPORTANT SAFEGUARDS

When using electrical products, especially when children are present, basic safety precautions should always be followed, including the following:

READ ALL INSTRUCTIONS BEFORE USING.

DANGER:

To reduce the risk of electrocution:

- Do not handle plug with wet hands.
- Do not place in or drop into water or other liquid.
- Do not use while bathing.
- Do not place or store product where it can fall or be pulled into a tub or sink.
- Do not reach for a product that has fallen into water. Unplug immediately.
- Check the power supply cord for damage before the first use and during the life of the product.

WARNING:

To reduce the risk of burns, electrocution, fire, or injury to persons:

- If product is opened/disassembled for ANY reason, warranty is **VOID**.
- Do not use this product if it has a damaged cord or plug, if it is not working properly, if it has been dropped or damaged, or dropped into any liquid. Contact Water Pik, International, Inc. UK Service Centre on +44 (0) 333 123 5677.
- Do not direct water under the tongue, into the ear, nose or other delicate areas. This product is capable of producing pressures that may cause serious damage in these areas.
- Use this product only as indicated in these instructions or as recommended by your dental professional.
- Only use tips and accessories recommended by Water Pik, Inc.

- Do not drop or insert any foreign object into any opening or hose unless otherwise stated.
- Keep electrical cord away from heated surfaces.
- Do not use outdoors or operate where aerosol (spray) products are being used or where oxygen is being administered.
- Do not use iodine or water insoluble concentrated essential oils in this product. Use of these can reduce performance and will shorten the life of the product. Use of these products may void warranty.
- Fill reservoir with water or other dental professional recommended solution only.
- Remove any oral jewelry prior to use of this product.
- Do not use if you have an open wound on your tongue or in your mouth.
- If your physician or cardiologist has advised you to receive antibiotic premedication before dental procedures, you should consult your dentist before using this instrument or any other oral hygiene aid.
- Do not use this product for more than 5 minutes in each two-hour period.
- Keep whitening tablet bottle and tablets out of reach of children and pets.
- Whitening tablets contain xylitol which may be harmful to pets.
- Fill reservoir with warm water or other dental professional recommended solution only.
- Children should be supervised to ensure that they do not play with the appliance.
- Closely instruct and supervise children 6 years and above and individuals with special needs in the proper use of this product.
- There are no consumer serviceable parts in this appliance and it does not require maintenance.

SAVE THESE INSTRUCTIONS

TABLE OF CONTENTS

| | |
|---|---|
| Product Description | 5 |
| Getting Started | 6 |
| Cleaning and Troubleshooting Your Waterpik® Water Flosser | 8 |
| Limited Two-Year Warranty | 9 |

- 1. Dual Purpose Lid**
Keeps out dust while storing extra tips
- 2. Reservoir**
90 Seconds of Water Capacity
- 3. Power Switch**
Easy-toggle
- 4. Pressure Control Dial**
Ergonomic Ribs for easy adjustment
- 5. Interchangeable Tips**
Personalize depending on tip preference
- 6. Single Press Flip Top Button**
Easy open for tablet loading
- 7. Water On/Off Control**
On/Off switch on handle for easy water control
- 8. Water Flosser Handle**
Handle hose swivel for easy access to all areas
- 9. Water Hose**

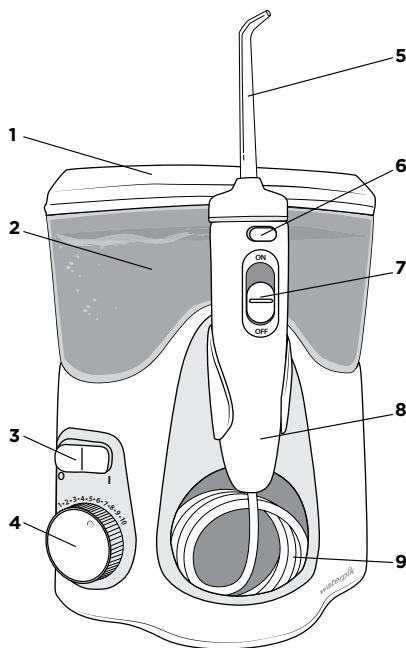

TIPS

Replace Every 3 months

A. Orthodontic Tip

- Braces/General Use

B. Plaque Seeker® Tip

- Implants/Crowns/Bridges/
Retainers/General Use

Replace Every 6 months

C. Classic Jet Tip

- General Use

NOTE: Tips sold with this model are unique in design for the whitening tablet handle. They are not compatible with traditional Water Flosser handles.

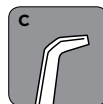
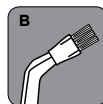
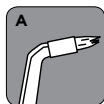

Replacement tips/attachments may be purchased directly from Waterpik International, Inc. +44 (0) 333 123 5677 or from your local Water Pik stockist.

Whitening Tablets

30-Count Bottle



GETTING STARTED

Powering the Unit

Plug the cord into an electrical outlet. If the outlet is controlled by a wall switch, be sure it is turned on.

Preparing the Reservoir

Remove the reservoir lid, remove the reservoir from base, and fill with lukewarm water. Replace the reservoir onto the base, press down firmly, replace reservoir lid.

Inserting and Removing Tips**Tip Insertion**

1. Press top button on handle to release flip top.
2. Insert tip through top, align notches on tip and handle (dots on tip and flip top will align).
3. Using thumb, press tip firmly into opening to click into place.
4. Close flip top. Check to ensure top is secured to handle prior to water flossing.

Tip Removal

1. Press top button on handle to release flip top.
2. Firmly push tip through opening to click out of position.

Prime Unit (First Time Use Only)

Set pressure control dial on base to high (pressure setting No.10), point the handle and tip into sink. Turn power and water ON until water flows. Turn water and power off.

NOTE: A tablet does NOT need to be loaded into handle for priming.

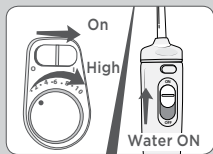
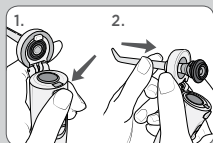
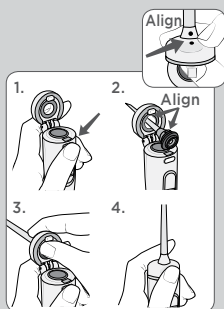
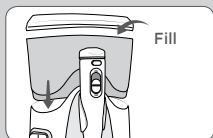

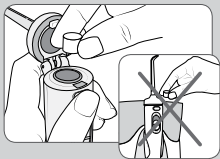

Tablet Loading

Insert tablet into water flosser handle by pressing the flip top button at top of handle. Insert tablet into opening and close flip top by clicking it securely into place on handle.

NOTE: Do NOT place tablet in reservoir.

Use one tablet daily to remove stains from hard to reach areas, between teeth, and at the gumline, that other products miss.

Adjusting the Pressure Setting

Turn the pressure control dial on the base of the unit to the lowest setting (pressure setting No.1) for first-time use. Gradually increase pressure over time to the setting you prefer – or as instructed by your dental professional.

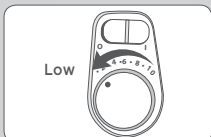

Using the Water Flosser

Always place the tip in your mouth before turning the power on.

With water switch on handle in OFF position, turn power on.

Lean over sink and slightly close lips enough to prevent splashing while still allowing water to flow from mouth into the sink. Turn water switch ON. When finished, turn water switch and power OFF.

During use you can stop the flow of water by sliding the water switch on handle to the OFF position.

NOTE: Motor will continue to run.



Recommended Technique

For best results, start with front teeth and work toward the back teeth. Direct the stream at a 90-degree angle to your gumline with tip in mouth. Glide tip along gumline and pause briefly between teeth. Continue until you have cleaned the inside and outside of both the upper and lower teeth.



When Finished

Turn the power OFF. Empty any liquid left in the reservoir. Unplug the unit.

NOTE: If you have any residual tablet left in the handle, simply discard in trash.

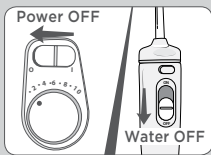

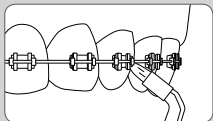

SPECIALTY TIP USAGE

Orthodontic Tip

To use the orthodontic tip, gently glide tip along gumline, pausing briefly to lightly brush area between teeth and all around orthodontic bracket, before proceeding to the next tooth.

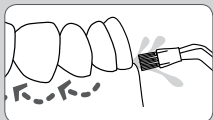

Plaque Seeker® Tip

To use the Plaque Seeker® tip, place the tip close to the teeth so that the bristles are gently touching the teeth. Gently glide tip along gumline, pausing briefly between teeth to gently brush and allow the water to flow between the teeth.

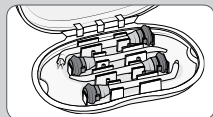

Accessory Storage

Accessory tip storage for your most frequently used tip is located under the reservoir lid.



Using Mouthwash and Other Solutions

Your Waterpik® Water Flosser can be used to deliver mouthwash and antibacterial solutions. After using any special solution, rinse unit to prevent clogging by partially filling reservoir with warm water and running unit with tip pointed into sink until unit is empty.

NOTE: Using mouthwash with tablet is **NOT** recommended. Unpleasant taste may occur.

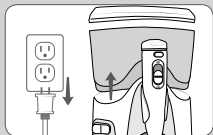

Cleaning

Before cleaning, unplug from the electrical outlet. Clean the product when necessary by using a soft cloth and mild non-abrasive cleanser. The water reservoir is removable for easy cleaning and is top rack dishwasher safe.

General Cleaning/Removing Hard Water Deposits

Hard water deposits may build up in your unit, depending on the mineral content of your water. If left unattended, it can hinder performance. Cleaning internal parts: add 2 tablespoons of white vinegar to a full reservoir of warm water. Point the handle and tip into sink. Turn unit ON and run until reservoir is empty. Rinse by repeating with a full reservoir of clean warm water.

This process should be done every 1 to 3 months to ensure optimal performance. If using mouthwash or other solutions, more frequent cleaning is recommended.

Leakage

If leaking due to a damaged hose, replacement hoses and handles can be purchased at www.waterpik.com or contact Water Pik Inc. customer service for a self service repair kit.

Service Maintenance

Waterpik® Water Flossers have no consumer-serviceable electrical items and do not require routine service maintenance. For all your service needs please call the Waterpik International, Inc. UK Customer Service Centre at +44 (0) 333 123 5677. Some replacement parts and accessories for the Water Flosser are also available at www.waterpik.co.uk.

For questions or problems please call the customer service centre before returning the product. Please do not send your unit to the Waterpik International, Inc. address as this can cause lengthy delays. Refer to the serial and model numbers in all correspondence. These numbers are on the bottom of the unit behind the reservoir. Water Pik, Inc. warrants to the original consumer of this new product that it is free from defects in materials and workmanship for 2 years from the date of purchase. Consumer will be required to submit the original purchase receipt as proof of purchase date and if requested, the entire product, to support a warranty claim. Water Pik, Inc. will replace at its discretion any part of the product, which in its opinion is defective, provided the product has not been abused, misused, altered or damaged after purchase, was used according to instructions, and was used only with accessories or consumable parts approved by Water Pik, Inc. Installation is the responsibility of the consumer and is not covered by the warranty. This limited warranty excludes accessories or consumable parts such as tips, batteries, etc. This warranty gives you specific legal rights. You may also have other rights that vary, depending on the law in your place of residence.

**Water Pik, Inc.**

1730 East Prospect Road
Fort Collins, CO 80553-0001 USA
USA 1-800-525-2774
Canada 1-888-226-3042

www.waterpik.com

Waterpik, International, Inc.

Castle Court, 41 London Road
Reigate, Surrey RH2 9RJ
United Kingdom
www.waterpik.co.uk

Waterpik, International, Inc.

UK Customer Service Centre
+44 (0) 333 123 5677

Waterpik® is a trademark of Water Pik, Inc. registered in Argentina, Australia, Benelux, Brazil, Canada, Chile, China, Czech Republic, Denmark, EU, Finland, France, Germany, Hong Kong, Hungary, India, Israel, Italy, Japan, Kazakhstan, Korea, Malaysia, Mexico, New Zealand, Norway, Pakistan, Philippines, Poland, Russian Federation, Saudi Arabia, Singapore, South Africa, Spain, Sweden, Switzerland, Taiwan, Turkey, Ukraine, United Kingdom, United States and Vietnam.

Waterpik® (stylized) is a trademark of Water Pik, Inc. registered in Australia, Brazil, Canada, China, EU, Hong Kong, India, Israel, Japan, Korea, Malaysia, Mexico, Philippines, Russian Federation, Saudi Arabia, South Africa, Switzerland, Taiwan, Thailand, Trinidad & Tobago, Ukraine, United States, and Vietnam.

waterflosser® (stylized) is a trademark of Water Pik, Inc. registered in Brazil, Canada, China, Mexico, Switzerland and the United States.

Plaque Seeker® is a trademark of Water Pik, Inc. registered in Canada, China, EU, and the United States.

Designed and Tested in the USA.

Made in China.

